

FLOW RATE INDICATOR / TOTALIZER

DISPLAYS FLOW RATE AND TOTAL
SIMULTANEOUSLY



Features

- Displays instantaneous flow rate, total and accumulated total.
- Large 17mm (0.67") digit selection for flow rate or total.
- Selectable on-screen engineering units.
- Ability to process all types of flowmeter signals.
- Auto backup of settings and running totals.
- Operational temperature -40°C up to +80°C (-40°F up to 176°F).
- Very compact design for panel mount, wall mount or field mount applications.
- Rugged aluminum field mount enclosure IP67/NEMA4X.
- Intrinsically Safe - ATEX, IECEx, FM and CSA approval for gas and dust applications.
- Explosion/flame proof Ex II 2 GD EEx d IIB T5.
- Easy configuration with clear alphanumeric display.
- LED backlight option.
- Loop or battery powered, 8 - 24V AC/DC or 115 - 230V AC power supply.
- Sensor supply 3.2 / 8.2 / 12 / 24V DC.

Signal input

Flow

- Reed-switch.
- NAMUR.
- NPN/PNP pulse.
- Sine wave (coil).
- Active pulse signals.
- (0)4 - 20mA.
- 0 - 10V DC.

Applications

- Flow measurement where a local flow rate indication and totalizer function is required without re-transmission functionality. Alternative basic models F010 and F011 or more advanced F013 - F014 - F016 - F110 and higher.

General information

Introduction

The F012 is a local indicator to display the actual flow rate, total and accumulated total. The total can be reset to zero by pressing the CLEAR button twice. The eleven digit accumulated total however can not be reset to zero. A wide selection of options further enhances the capabilities of this model, including Intrinsic Safety for hazardous area applications.

Display

The display has large 17mm (0.67") and 8mm (0.31") digits which can be set to show flow rate and / or totals. On-screen engineering units are easily configured from a comprehensive selection. The accumulated total can register up to 11 digits and is backed-up in EEPROM memory every minute, just as the running total. As the F012 has been designed for field mounted applications, a smart display update function has been incorporated. Related to the lower temperatures, the update frequency of the LCD is tuned automatically to achieve a readable display even at -40°C / -40°F.

Backlight

For those applications where readability during day and night is an issue, a bi-color backlight is available. The background color can be set to green or amber and the intensity can be adjusted from the keyboard. The display is a transfective type, which means that a high contrast reading is guaranteed in full sunlight as well as during the night. This backlight option is also available Intrinsically Safe.

Configuration

All configuration settings are accessed via a simple operator menu which can be pass-code protected. Each setting is clearly indicated with an alphanumerical description, which avoids confusing abbreviations and baffling codes. Once familiar with one F-series product, you will be able to program all models in the series without a manual. All settings are safely stored in EEPROM memory in the event of sudden power failure.

Signal input

The F012 accepts most pulse and analog input signals for volumetric flow or mass flow measurement. The input signal type can be selected by the user in the configuration menu without having to adjust any sensitive mechanical dip-switches, jumpers or trimmers. The analog input version is even available as 4 - 20mA input loop powered display.

Power supply

Several power supply options are available to power the F012 and sensor. Most popular is our battery powered version with a long life lithium battery which will last up to five years. For analog sensors, a 4 - 20mA loop powered version is available as well. A real sensor supply is offered with the 24V AC/DC or 115 - 230V AC power supply option.

Hazardous area

For hazardous area applications, this model has been ATEX, IECEx, FM and CSA certified Intrinsically Safe for gas and dust applications, with an allowed operational temperature of -40°C to +70°C (-40°F to +158°F). A flame proof enclosure with ATEX certification offers the rating $\text{Ex} \text{II} 2 \text{GD} \text{EEx} \text{d} \text{IIB} \text{T5}$.

Enclosures

Various types of enclosures can be selected, all ATEX, IECEx, FM and CSA approved. As standard the F012 is supplied in an GRP panel mount enclosure, which can be converted to an IP67 / NEMA 4X GRP field mount enclosure by the addition of a back case. Most popular is our aluminum field mount enclosure with IP67 / NEMA 4X rating. Both European or U.S. cable gland entry threads are available.

Overview application F012

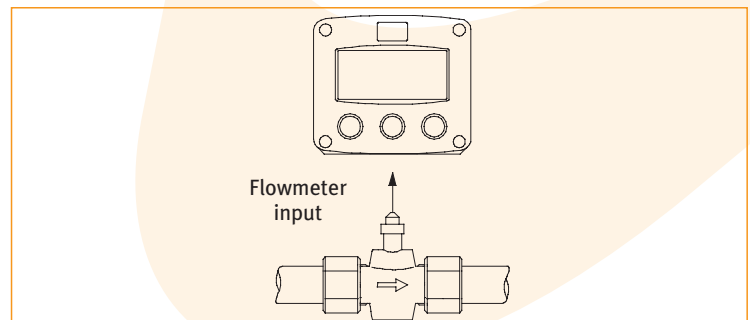

Dimensions enclosures Aluminum & GRP panel mount enclosure

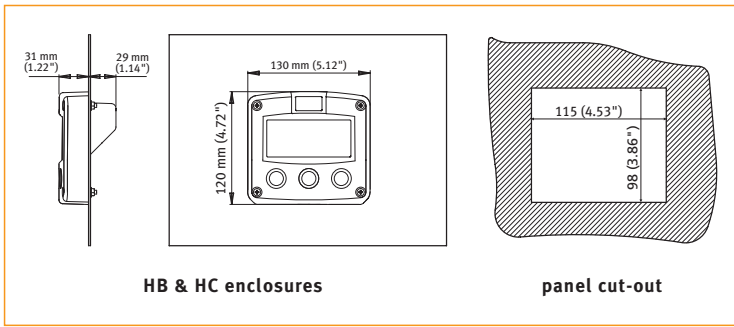

Aluminum & GRP field / wall mount enclosures

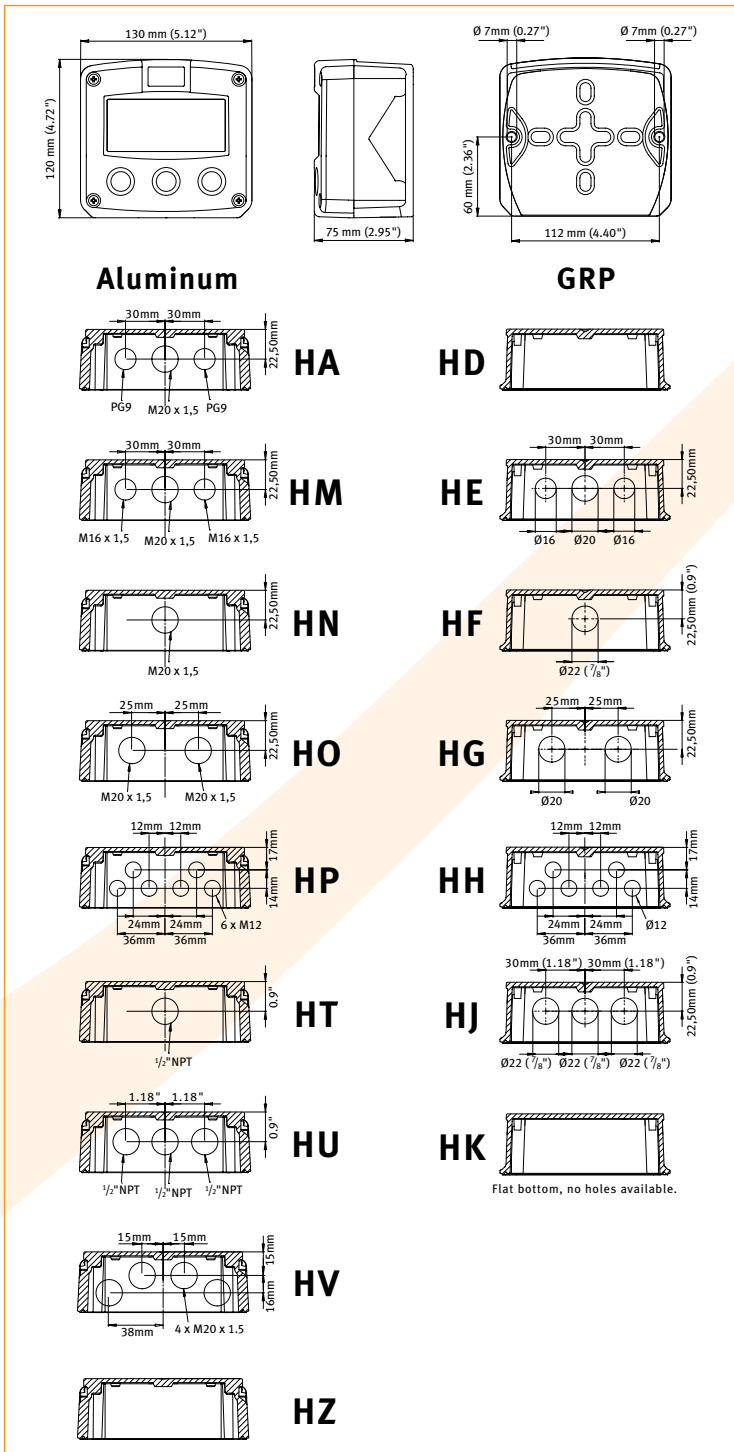

Terminal connections power supply PB/PC - PD - PL - PX

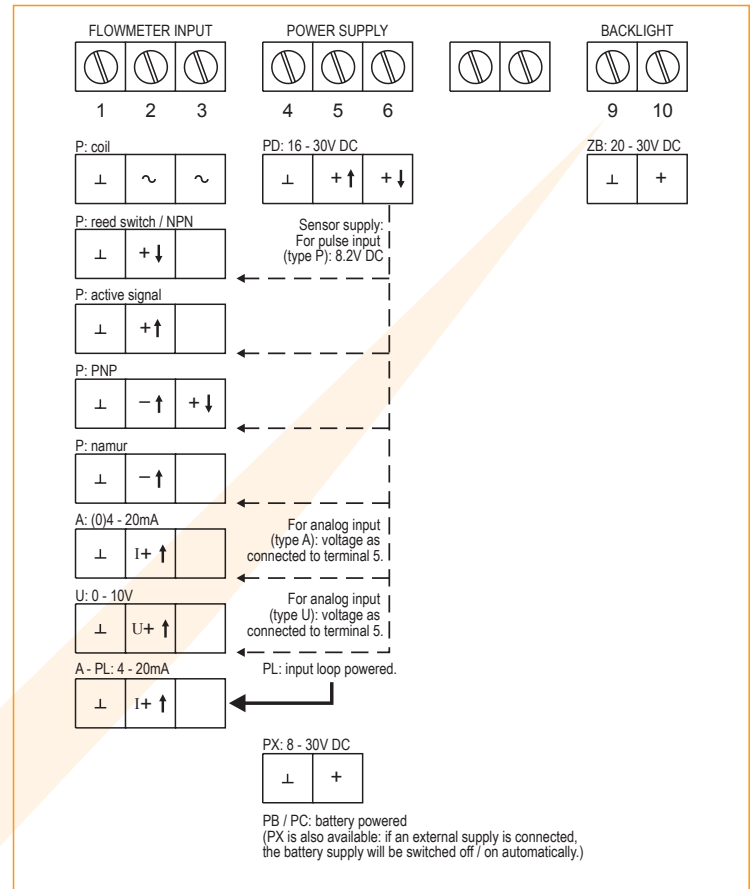

Terminal connections power supply PF - PM

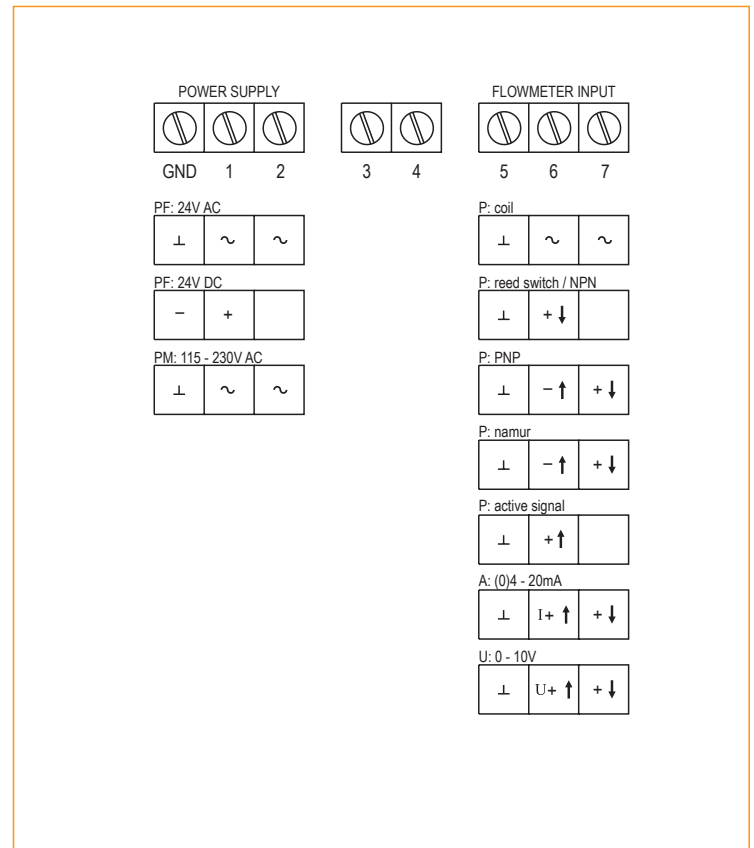

Typical wiring diagram Fo12-P-PB-(PX)-(ZB)

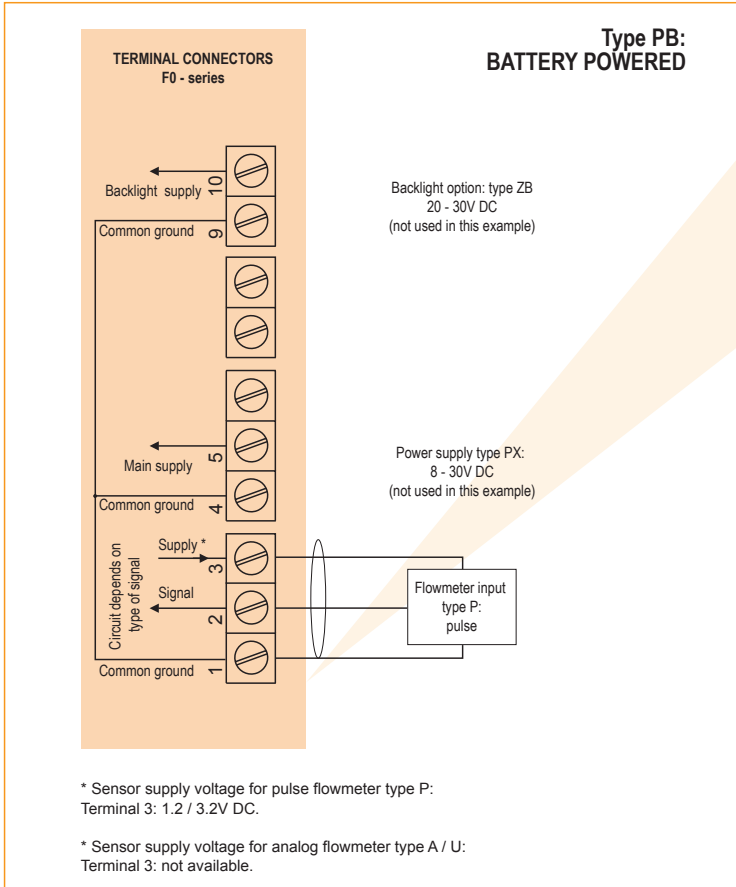

Typical wiring diagram Fo12-A-PX-ZB

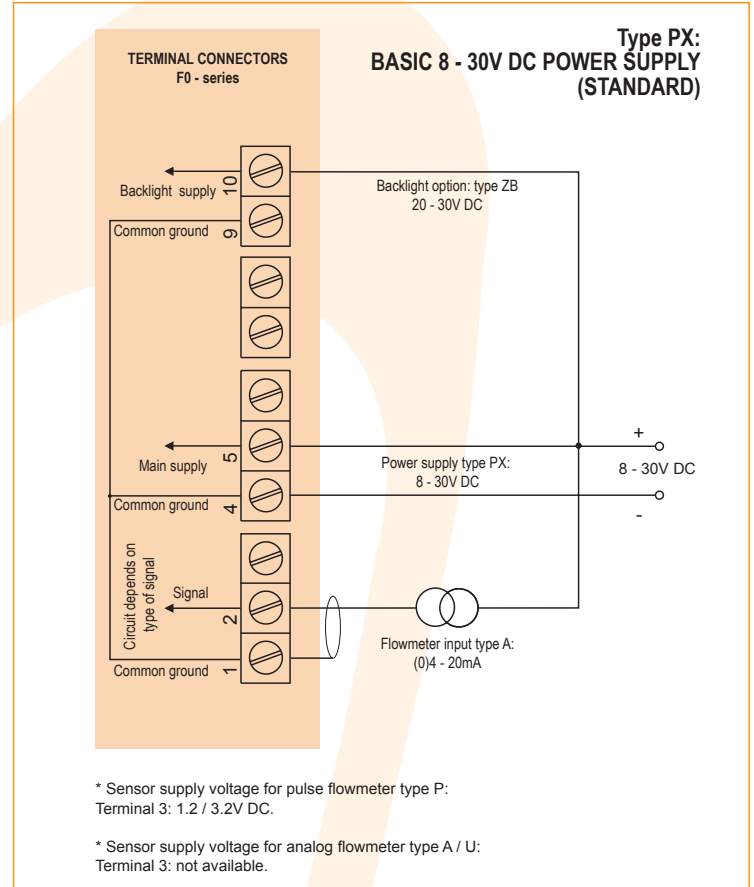

Typical wiring diagram Fo12-A-PL-ZB

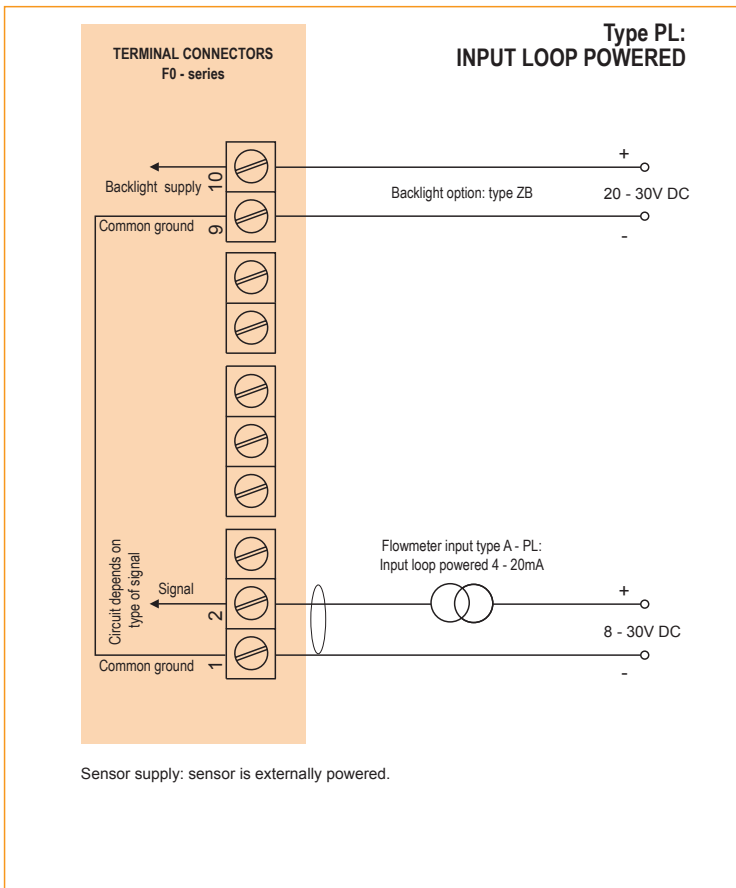

Typical wiring diagram Fo12-P-PD-ZB

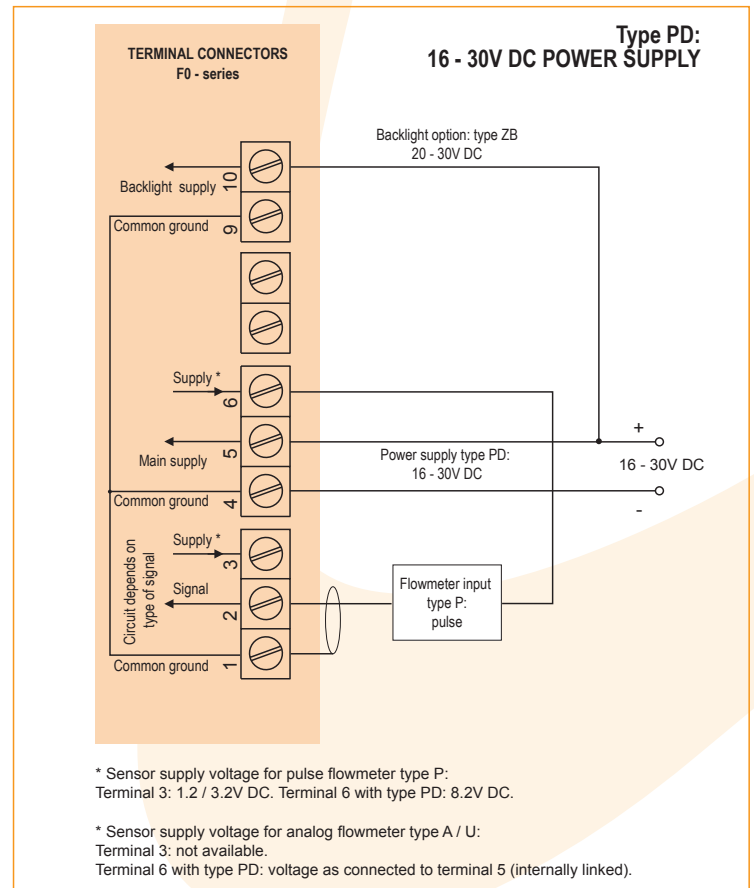

Typical wiring diagram Fo12-P-PF-ZB

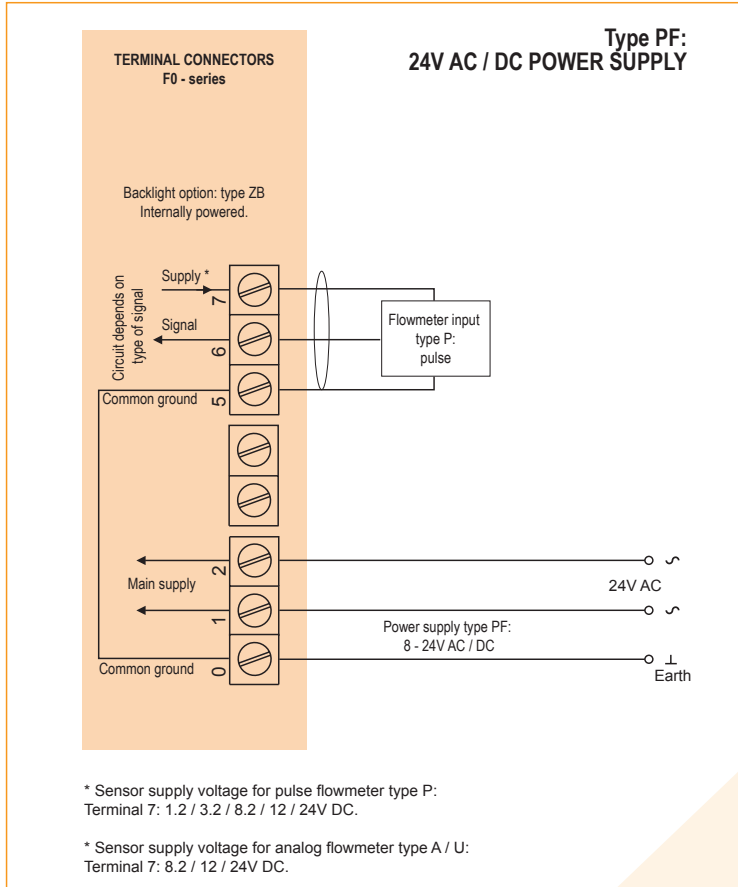

Typical wiring diagram Fo12-A-PF-ZB

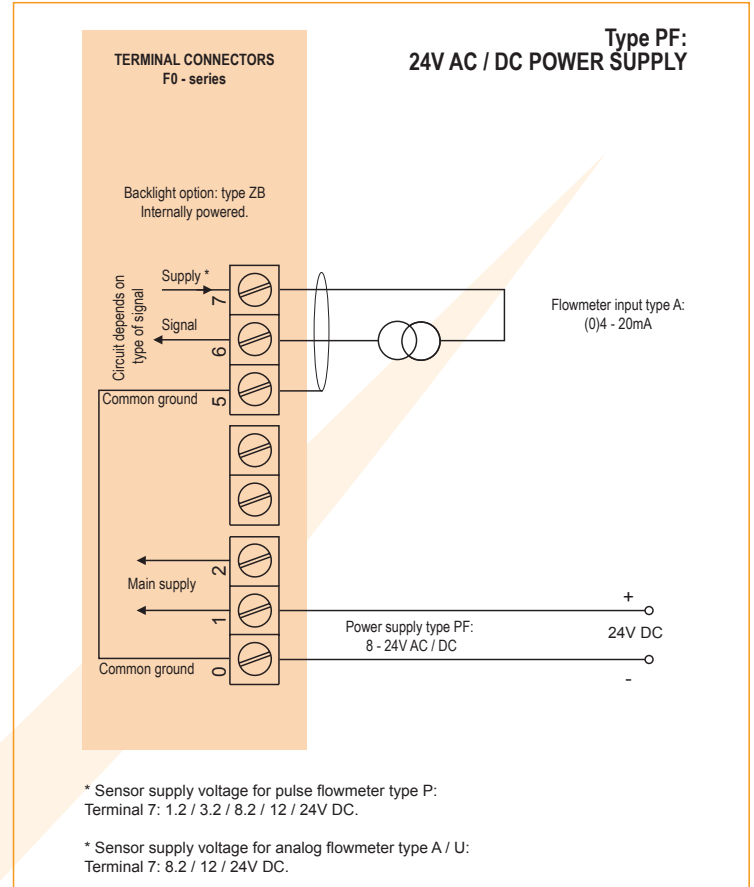

Typical wiring diagram Fo12-A-PM-ZB

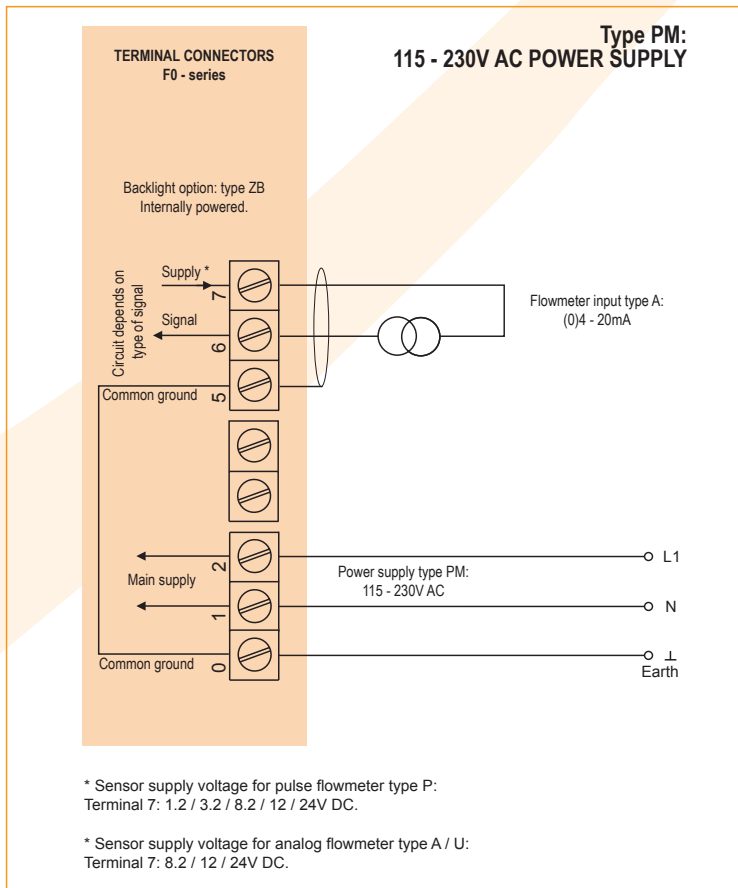

Typical wiring diagram Fo12-P-PM-ZB

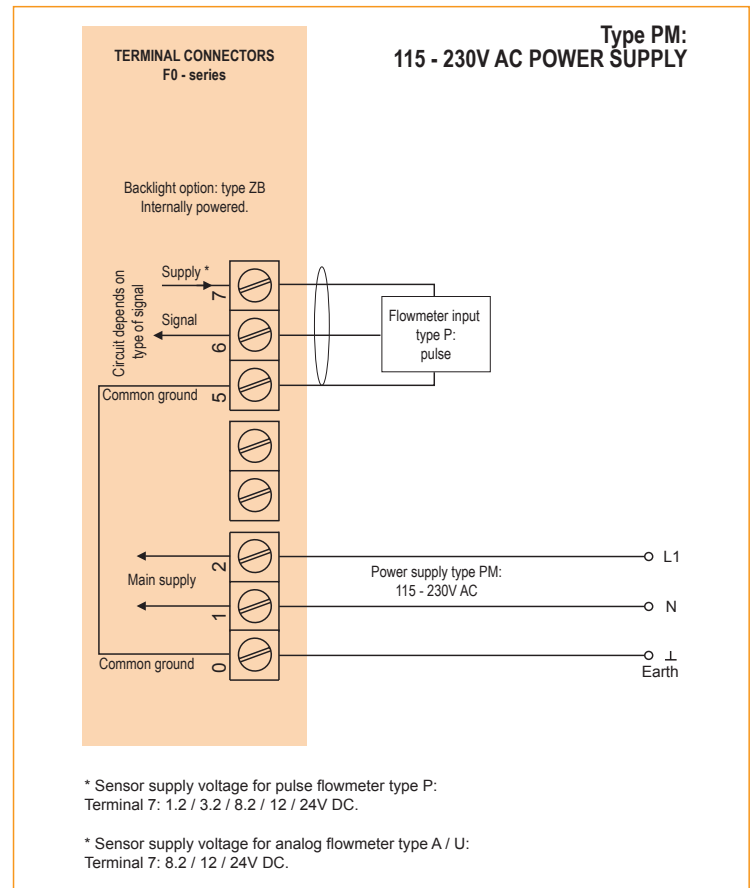

Hazardous area applications

The F012-XI has been certified according ATEX and IECEx by KEMA and according CSA c-us and FM for use in Intrinsically Safe applications with an ambient temperature of -40°C to +70°C (-40°F to +158°F).

- The ATEX markings for gas and dust applications are:

II 1 G Ex ia IIC T4
II 1 D Ex iaD 20 IP 65/67 T 100 [C].

- The IECEx markings for gas and dust applications are: **Ga Ex ia IIC T4** and **Ex iaD 20 IP 65/67 T100 [C].**
- The CSA c-us markings are: **Class I/II/III, Division 1, Groups A, B, C, D, E, F, G, Temperature class T4 and Class I, Zone 0, AEx ia IIC T4.**
- The FM markings are: **Class I/II/III, Division 1, Groups A, B, C, D, E, F, G, Temperature class T4 and Class I, Zone 0, AEx ia IIC T4.**

It is allowed to connect up to three I.S. power supplies to power the unit, sensor and backlight. Consult the certificate for the maximum input and output values of the circuits. The F012-PD-XI offers a 8.2V DC sensor supply to power e.g. a Namur sensor or the input voltage to power an analog sensor. An ATEX approved flame proof enclosure with rating **Ex II 2 GD EEx d IIB T5** is available as well. Please contact your supplier for further details.

Certificate of conformity KEMA 05ATEX1168 X
• IECEx KEM 08.0006X • CSA.08.2059461 X

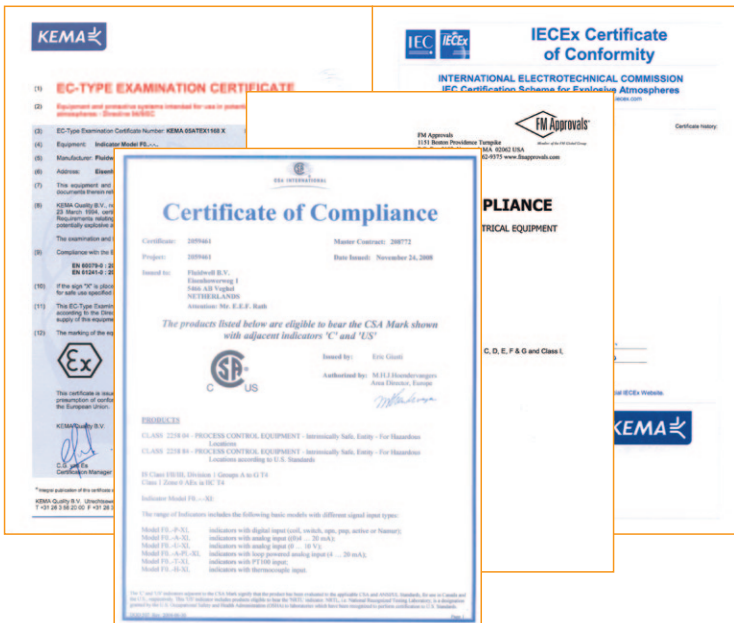

Configuration example IIA - IIB and IIC F012-P-PC-(PX)-XI-(ZB) - Battery powered unit

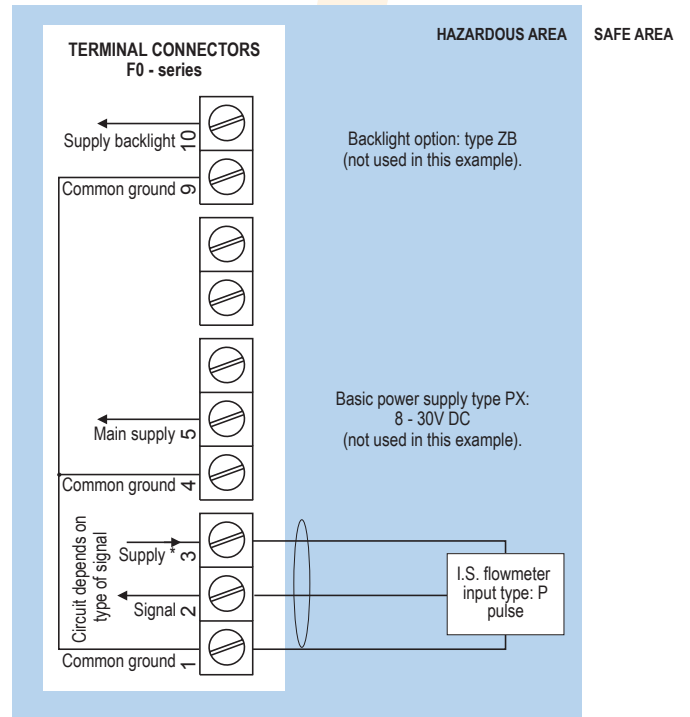

* Sensor supply voltage for pulse flowmeter type P : Terminal 3: 1.2 / 3.2V DC.
Please note: type PX may be used in combination with the battery (type PC).
PX will power the unit; the battery will be disabled automatically till power is disconnected.

Configuration example IIA - IIB and IIC - F012-P-PX-XI-(ZB) - Basic power supply 8 - 30V DC

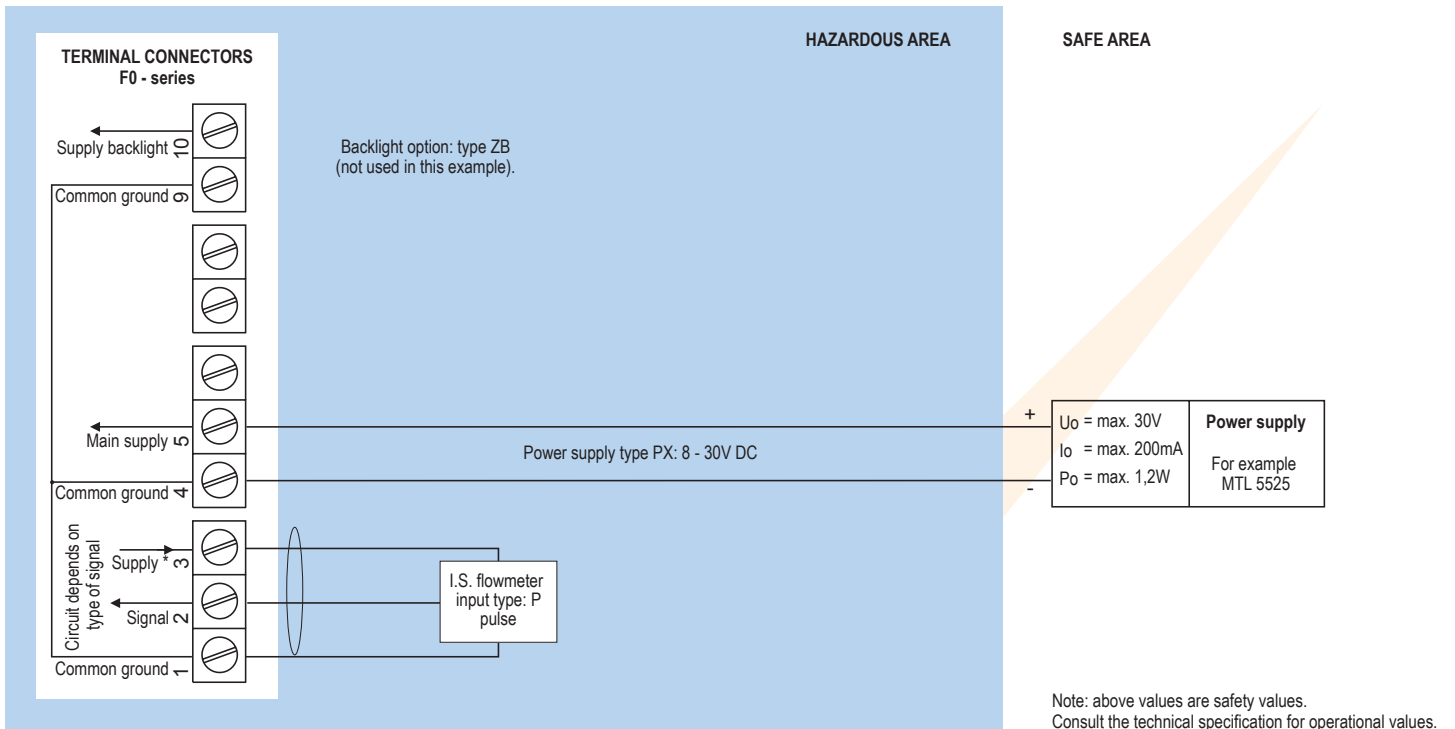

* Sensor supply voltage for pulse type P: Terminal 3: 1.2V / 3.2V DC.

Please note: type PX may be used in combination with the battery (type PC). PX will power the unit; the battery will be disabled automatically till power is disconnected.

Configuration example IIA - IIB and IIC - F012-P-PX-XI-ZB - Basic power supply 8 - 30V DC

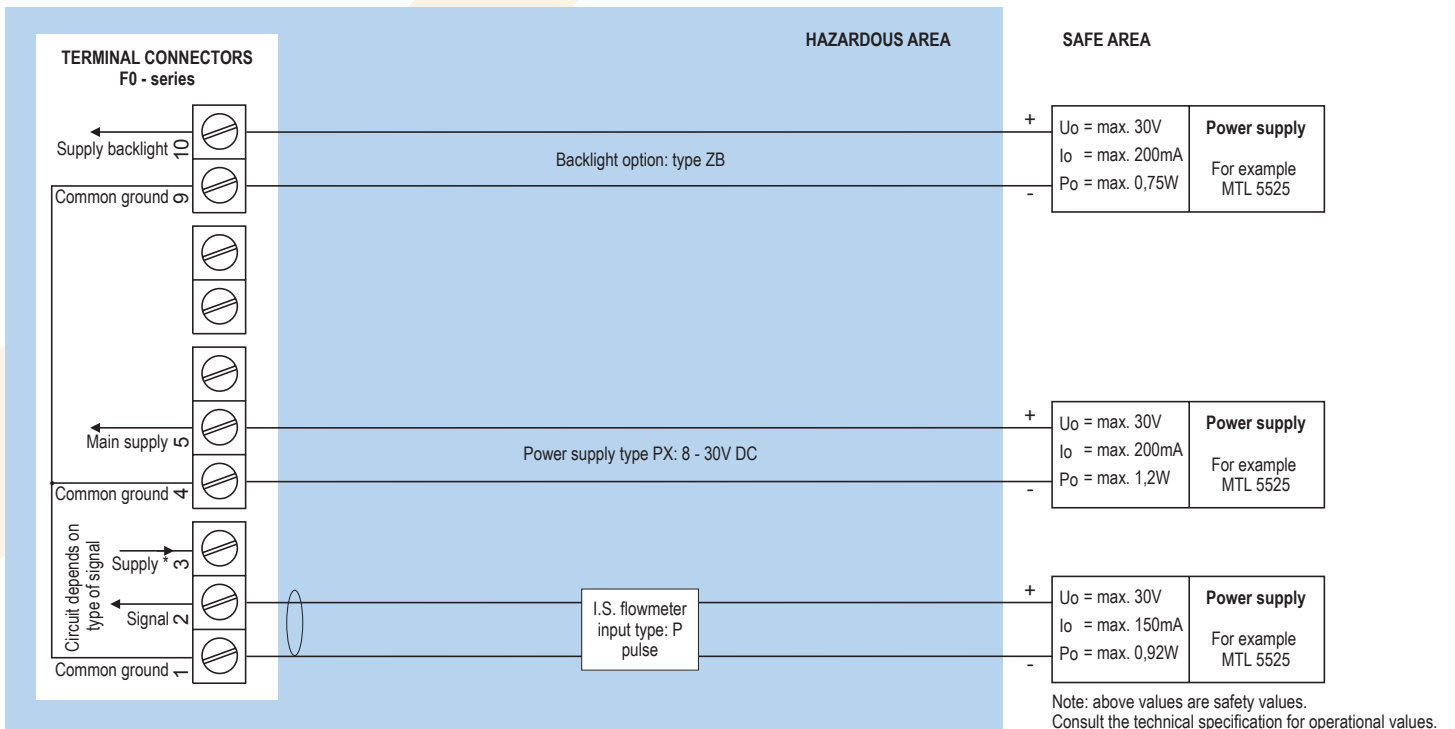

* Sensor supply voltage for pulse type P: Terminal 3: 1.2V / 3.2V DC.

Please note: type PX may be used in combination with the battery (type PC). PX will power the unit; the battery will be disabled automatically till power is disconnected.

Configuration example IIA - IIB and IIC - F012-P-PD-XI-ZB - Power supply 16 - 30V DC

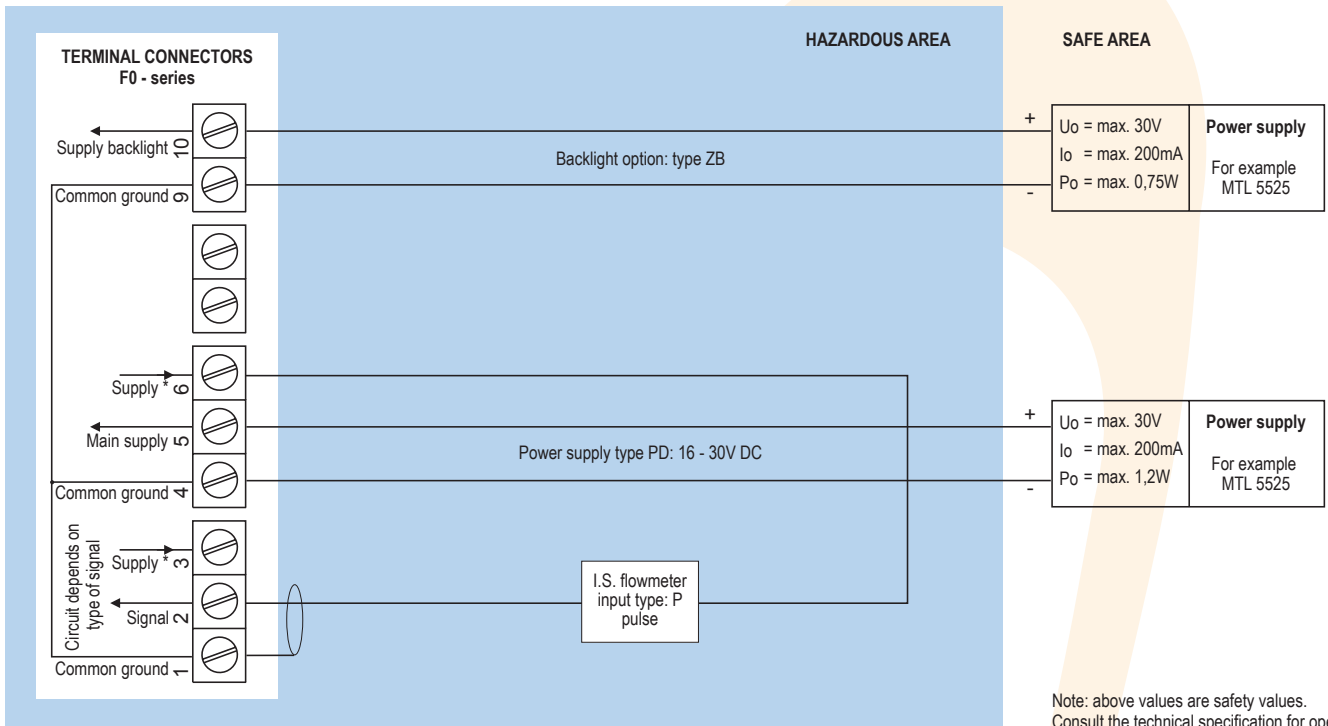

Note: above values are safety values.
Consult the technical specification for operational values.

* Sensor supply voltage for pulse type P: Terminal 3: 1.2V / 3.2V DC. Terminal 6: 8.2V DC.

Please note: type PD may be used in combination with the battery (type PC). PD will power the unit; the battery will be disabled automatically till power is disconnected.

Configuration example IIA - IIB and IIC - F012-A-PD-XI-ZB - Power supply 16 - 30V DC

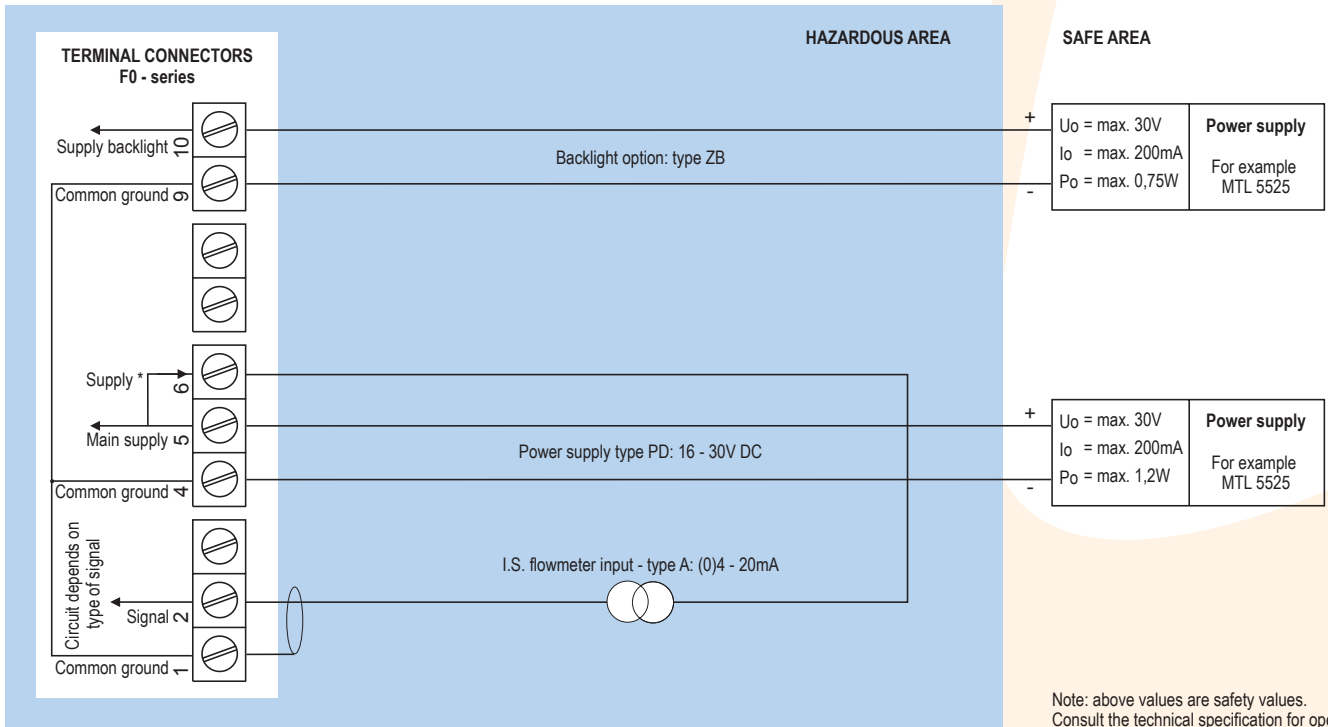

Note: above values are safety values.
Consult the technical specification for operational values.

* Sensor supply voltage for analog flowmeter type A / U: Terminal 6: as input voltage terminal 5 (internally linked).

Please note: type PD may be used in combination with the battery (type PC). PD will power the unit; the battery will be disabled automatically till power is disconnected.

Configuration example IIA - IIB and IIC - F012-A-PL-XI-ZB - Input loop powered

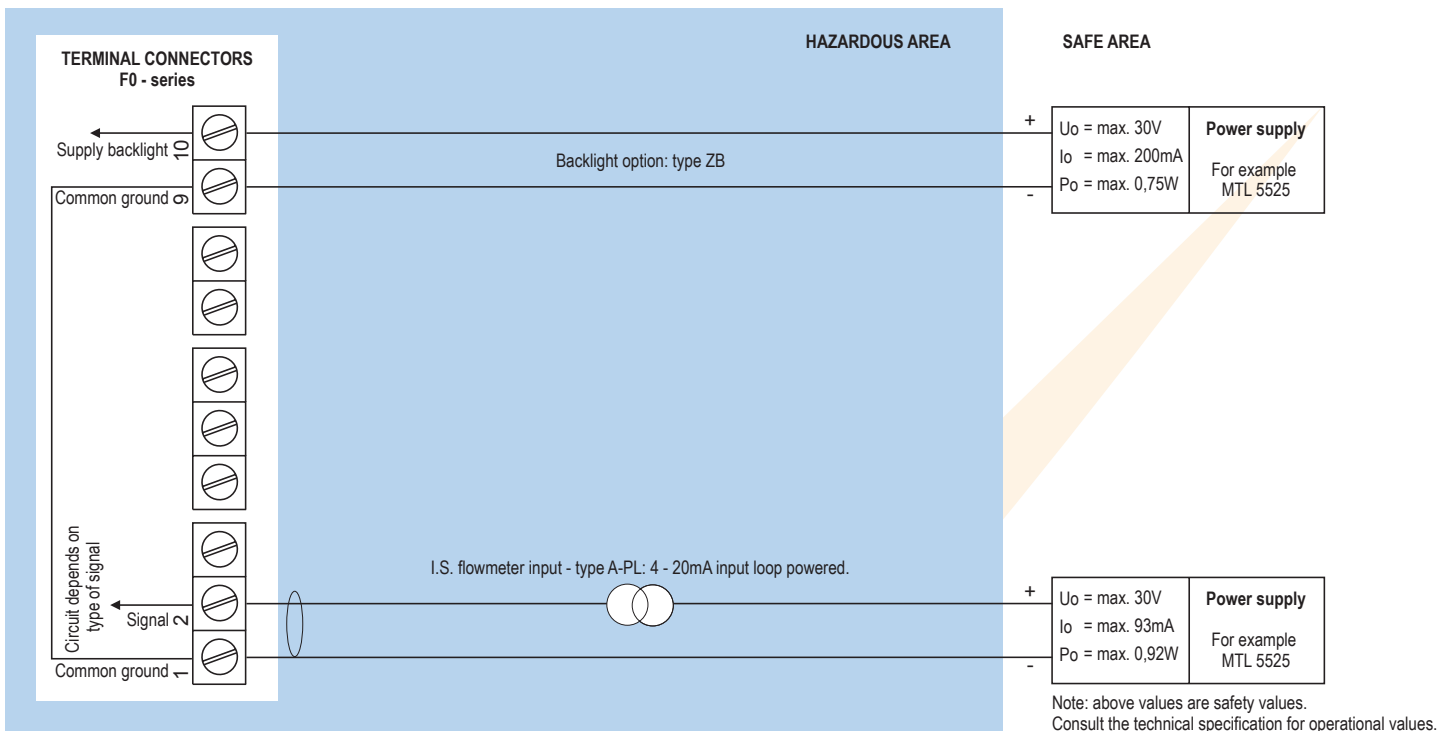

Sensor supply is not available: unit is input loop powered (type PL).
Please note: type PL may be used in combination with the battery (type PC). PL will power the unit; the battery will be disabled automatically till power is disconnected.

Configuration example IIA - IIB and IIC - F012-A-PX-XI-ZB - Basic power supply 8 - 30V DC

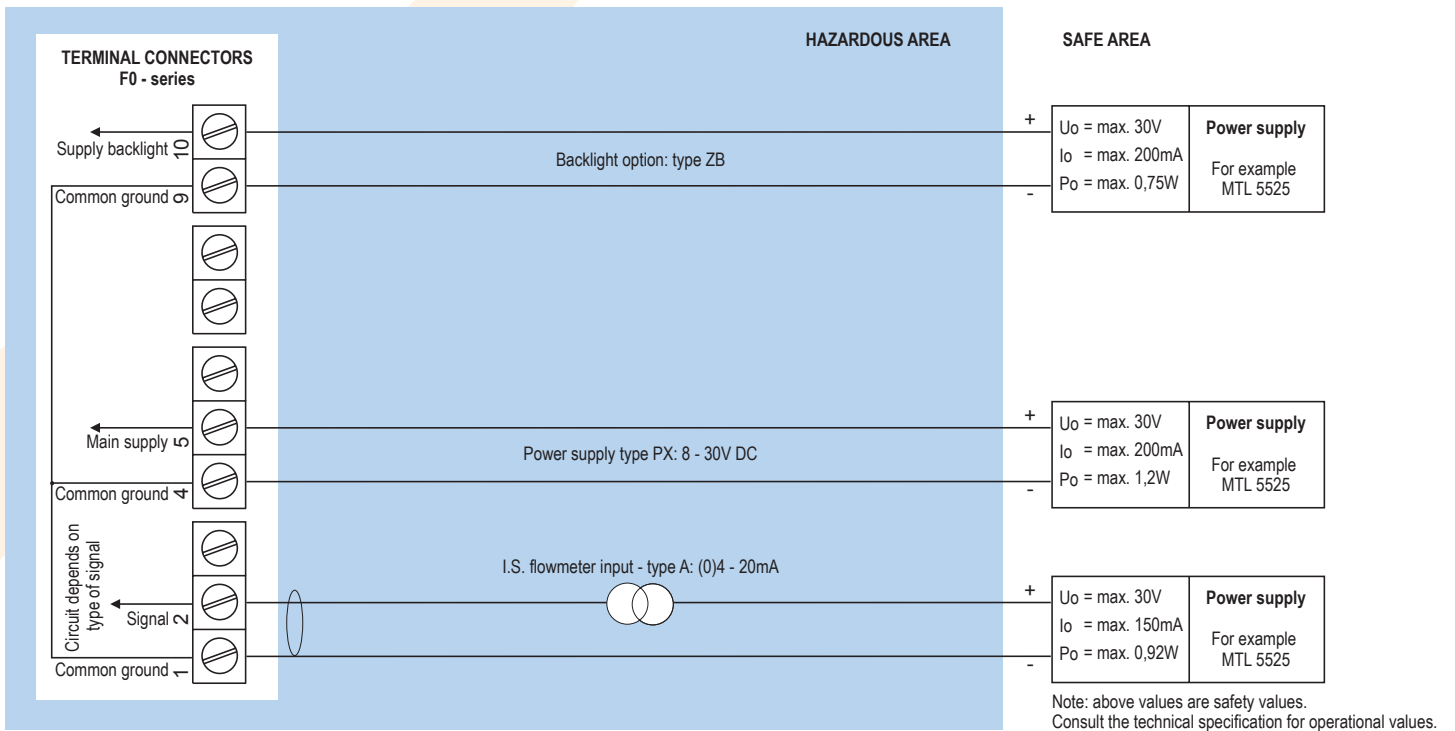

* Sensor supply voltage for analog flowmeter type A / U: not available in this example.
Please note: type PX may be used in combination with the battery (type PC). PX will power the unit; the battery will be disabled automatically till power is disconnected.

Technical specification

General

Display	
Type	High intensity reflective numeric and alphanumeric LCD, UV-resistant.
Dimensions	90 x 40mm (3.5" x 1.6").
Digits	Seven 17mm (0.67") and eleven 8mm (0.31") digits. Various symbols and measuring units.
Refresh rate	User definable: 8 times/sec. - 1 time/30 secs - off.
Option ZB	Transflective LCD with bi-color LED-backlight; green / amber. Intensity and color selected through the keyboard. Good readings in full sunlight and darkness. Also available Intrinsically Safe.

Operating temperature

Standard unit	-40°C to +80°C (-40°F to +176°F).
Intrinsically Safe	-40°C to +70°C (-40°F to +158°F).

Power requirements

Type PB	Long life Lithium battery - life-time depends upon settings and configuration - up to 5 years.
Type PC	Intrinsically Safe long life lithium battery - life-time depends upon settings and configuration - up to 5 years.
Type PD	16 - 30V DC. Power consumption max. 1 Watt.
Type PF	24V AC / DC ± 10%. Power consumption max. 15 Watt.
Type PL	Input loop powered from sensor signal 4 - 20mA (type A).
Type PM	115 - 230V AC ± 10%. Power consumption max. 15 Watt.
Type PX	8 - 30V DC. Power consumption max. 0.3 Watt.
Type ZB	20 - 30V DC. Power consumption max. 1 Watt. With type PF / PM: internally powered.
Note PB/PF/PM	Not available Intrinsically Safe.
Note PF/PM	The total consumption of the sensor and backlight type ZB may not exceed 400mA @ 24V DC.
Note	For Intrinsically Safe applications, consult the safety values in the certificate.

Sensor excitation

Type PB/PC/PX	3.2V DC for pulse signals and 1.2V DC for coil pick-up.
Note	This is not a real sensor supply. Only suitable for sensors with a very low power consumption like coils (sine wave) and reed-switches.
Type PD	for pulse signals: 1.2 / 3.2 / 8.2V DC - max. 5mA@8.2V DC. For analog signals, the sensor supply voltage is according to the power supply voltage connected.
Type PF / PM	With pulse input: 1.2 / 3.2 / 8.2 / 12 / 24V DC - max. 400mA @ 24V DC. With analog input: 8.2 / 12 / 24V DC - max. 400mA @ 24V DC.

Terminal connections

Type	Removable plug-in terminal strip. Wire max. 1.5mm ² and 2.5mm ² .
------	---

Data protection

Type	EEPROM backup of all settings. Backup of running totals every minute. Data retention at least 10 years.
Pass-code	Configuration settings can be pass-code protected.

Casing

General

Window	Polycarbonate window.
Sealing	Silicone.
Control keys	Three industrial micro-switch keys. UV-resistant silicone keypad.

Aluminum wall / field mount enclosures

General	Die-cast aluminum wall/field mount enclosure IP67 / NEMA 4X with 2-component UV-resistant coating.
Dimensions	130 x 120 x 75mm (5.12" x 4.72" x 2.95") - W x H x D.
Weight	1100 gr.
Type HA	Cable entry: 2 x PG9 and 1 x M20.
Type HM	Cable entry: 2 x M16 and 1 x M20.
Type HN	Cable entry: 1 x M20.
Type HO	Cable entry: 2 x M20.
Type HP	Cable entry: 6 x M12.
Type HT	Cable entry: 1 x 1/2" NPT.
Type HU	Cable entry: 3 x 1/2" NPT.
Type HV	Cable entry: 4 x M20.
Type HZ	Cable entry: no holes.

GRP wall / field mount enclosures

General	GRP wall/field mount enclosure IP67 / NEMA 4X, UV-resistant and flame retardant.
Dimensions	130 x 120 x 75mm (5.12" x 4.72" x 2.95") - W x H x D.
Weight	600 gr.
Type HD	Cable entry: no holes.
Type HE	Cable entry: 2 x Ø 16mm and 1 x Ø 20mm.
Type HF	Cable entry: 1 x Ø 22mm (7/8").
Type HG	Cable entry: 2 x Ø 20mm.
Type HH	Cable entry: 6 x Ø 12mm.
Type HJ	Cable entry: 3 x Ø 22mm (7/8").
Type HK	Flat bottom, cable entry: no holes.

Panel mount enclosures





Dimensions	130 x 120 x 60mm (5.12" x 4.72" x 2.36") - W x H x D.
Panel cut-out	115 x 98mm (4.53" x 3.86") L x H.
Type HB	Die-cast aluminum panel mount enclosure IP65 / NEMA 4X.
Weight	600 gr.
Type HC	GRP panel mount enclosure IP65 / NEMA 4X, UV-resistant and flame retardant.
Weight	450 gr.

ABS wall / field mount enclosures

General	Silicone free ABS wall/field mount enclosure IP65 with EPDM and PE sealings. UV-resistant polyester keypad (old HD enclosure).
Dimensions	130 x 114 x 71mm (5.1" x 4.5" x 2.8") - W x H x D.
Weight	450 gr.
Type HS	Cable entry: no holes.

Hazardous area

Intrinsically Safe

ATEX certification	 II 1 G Ex ia IIC T4. II 1 D Ex iaD 20 IP 65 / 67 T 100 °C.
IECEX certification	 Ga Ex ia IIC T4. Ex iaD 20 IP 65 / 67 T 100 °C.
CSA c-us certification	 Intrinsically Safe for Class I/II/III, Div. 1, Groups A, B, C, D, E, F, G, Temp. class T4 and Class I, Zone o, AEx ia IIC T4.
FM certification	 Intrinsically Safe for Class I/II/III, Div. 1, Groups A, B, C, D, E, F, G, Temp. class T4 and Class I, Zone o, AEx ia IIC T4.
Ambient Ta	-40°C to +70°C (-40°F to +158°F).

Explosion proof

ATEX certification	Ex II 2 GD EEx d IIB T5.
Type XF	Dimensions of enclosure: 300 x 250 x 200mm (11.8" x 9.9" x 7.9") L x H x D.
Weight	Appr. 15kg.

Environment

Electromagnetic compatibility	Compliant ref: EN 61326 (1997), EN 61010-1 (1993).
-------------------------------	--

Signal input

Flowmeter sensor

Type P	Coil / sine wave (minimum 20mVpp or 80mVpp - sensitivity selectable), NPN/PNP, open collector, reed-switch, Namur, active pulse signals 8 - 12 and 24V DC.
Frequency	Minimum 0Hz - maximum 7kHz for total and flow rate. Maximum frequency depends on signal type and internal low-pass filter. E.g. reed switch with low-pass filter: max. frequency 120Hz.
K-Factor	0.000010 - 9,999,999 with variable decimal position.
Low-pass filter	Available for all pulse signals.
Option ZF	coil sensitivity 10mVpp.
Option ZG	coil sensitivity 5mVpp.
Type A	(0)4 - 20mA. Analog input signal can be scaled to any desired range within 0 - 20mA.
Type U	0 - 10V DC. Analog input signal can be scaled to any desired range within 0 - 10V DC.
Accuracy	Resolution: 16 bit. Error < 0.01mA / ± 0.05% FS. Low level cut-off programmable.
Span	0.001 / 999,999 with variable decimal position.
Update time	Four times per second.
Voltage drop	Type A: max. 2V DC @ 20mA.
Voltage drop	Type A - PL (loop powered): max. 2.6V DC @ 20mA.
Load impedance	Type U: 3kΩ.
Relationship	Linear and square root calculation.
Note	For signal type A and U: external power to sensor is required; e.g. type PD.

Operational

Operator functions

Displayed functions	<ul style="list-style-type: none">• Flow rate and / or total.• Total and accumulated total.• Total can be reset to zero by pressing the CLEAR-key twice.
---------------------	--

Total

Digits	7 digits.
Units	L, m ³ , GAL, USGAL, kg, lb, bbl, no unit.
Decimals	0 - 1 - 2 or 3.
Note	Total can be reset to zero.

Accumulated total

Digits	11 digits.
Units / decimals	According to selection for total.
Note	Can not be reset to zero.

Flow rate

Digits	7 digits.
Units	mL, L, m ³ , Gallons, kg, Ton, lb, bl, cf, RND, ft ³ , scf, Nm ³ , NI, igal - no units.
Decimals	0 - 1 - 2 or 3.
Time units	/sec - /min - /hr - /day.

Accessories

Mounting accessories

ACFo2	Stainless steel wall mounting kit.
ACFo5	Stainless steel pipe mounting kit (worm gear clamps not included).
ACFo6	Two stainless steel worm gear clamps Ø 44 - 56mm.
ACFo7	Two stainless steel worm gear clamps Ø 58 - 75mm.
ACFo8	Two stainless steel worm gear clamps Ø 77 - 95mm.
ACFo9	Two stainless steel worm gear clamps Ø 106 - 138mm.
ACF10	Customized Grevopal tagplates for ACFo2 and ACFo5, including stainless steel screws. Dimension: 95mm x 12.5mm (3.75" x 0.50").

Cable gland accessories

ACF20	For HA enclosure, includes O-rings.
ACF25	For HE enclosure, includes locknuts and O-rings.
ACF26	For HF enclosure, includes locknuts and O-rings.
ACF27	For HG enclosure, includes locknuts and O-rings.
ACF28	For HH enclosure, includes locknuts and O-rings.
ACF29	For HJ enclosure, includes locknuts and O-rings.
ACF32	For HM enclosure, includes O-rings.
ACF33	For HN enclosure, includes O-rings.
ACF34	For HO enclosure, includes O-rings.
ACF35	For HP enclosure, includes O-rings.
ACF39	For HT enclosure, includes O-rings.
ACF40	For HU enclosure, includes O-rings.

Blind plug accessories

ACF50	For HA enclosure, includes O-rings.
ACF55	For HE enclosure, includes locknuts and O-rings.
ACF56	For HF enclosure, includes locknuts and O-rings.
ACF57	For HG enclosure, includes locknuts and O-rings.
ACF58	For HH enclosure, includes locknuts and O-rings.
ACF59	For HJ enclosure, includes locknuts and O-rings.
ACF62	For HM enclosure, includes O-rings.
ACF63	For HN enclosure, includes O-rings.
ACF64	For HO enclosure, includes O-rings.
ACF65	For HP enclosure, includes O-rings.
ACF69	For HT enclosure, includes O-rings.
ACF70	For HU enclosure, includes O-rings.

Display example - 90 x 40mm (3.5" x 1.6")



Ordering information

Standard configuration: F012-P-HC-PX-XX-ZX.

ordering information:	F012	-	-H	-P	-X	-Z
Flowmeter Sensor input signal						
A	⊗ (o)4 - 20mA input.					
P	⊗ Pulse input: coil, npn, pnp, namur, reed-switch.					
U	⊗ 0 - 10V DC input.					
Panel mount enclosures - IP65 / NEMA4X						
HB	⊗ Aluminum enclosure.					
HC	⊗ GRP enclosure.					
GRP field / wall mount enclosures - IP67 / NEMA4X						
HD	⊗ Cable entry: no holes.					
HE	⊗ Cable entry: 2 x Ø 16mm & 1 x Ø 20mm.					
HF	⊗ Cable entry: 1 x Ø 22mm (7/8").					
HG	⊗ Cable entry: 2 x Ø 20mm.					
HH	⊗ Cable entry: 6 x Ø 12mm.					
HJ	⊗ Cable entry: 3 x Ø 22mm (7/8").					
HK	⊗ Flat bottom, cable entry: no holes.					
Aluminum field / wall mount enclosures - IP67 / NEMA4X						
HA	⊗ Cable entry: 2 x PG9 + 1 x M20.					
HM	⊗ Cable entry: 2 x M16 + 1 x M20.					
HN	⊗ Cable entry: 1 x M20.					
HO	⊗ Cable entry: 2 x M20.					
HP	⊗ Cable entry: 6 x M12.					
HT	⊗ Cable entry: 1 x 1/2" NPT.					
HU	⊗ Cable entry: 3 x 1/2" NPT.					
HV	⊗ Cable entry: 4 x M20.					
HZ	⊗ Cable entry: no holes.					
ABS field / wall mount enclosures - IP65						
HS	⊗ Silicone free ABS field enclosure – Cable entry: no holes (old HD enclosure).					
Power supply						
PB	Lithium battery powered.					
PC	⊗ Lithium battery powered - Intrinsically Safe.					
PD	⊗ 16 - 30V DC + sensor supply.					
PF	24V AC / DC + sensor supply.					
PL	⊗ Input loop powered from sensor signal 4 - 20mA (type A).					
PM	115 - 230V AC + sensor supply.					
PX	⊗ Basic power supply 8 - 30V DC (no real sensor supply).					
Hazardous area						
XI	⊗ Intrinsically Safe, according ATEX, IECEx, CSA c-us and FM.					
XF	EExd enclosure - 3 keys.					
XX	Safe area only.					
Other options						
ZB	⊗ Backlight.					
ZF	⊗ Coil input 10mVpp.					
ZG	⊗ Coil input 5mVpp.					
ZX	⊗ No options.					

The bold marked text contains the standard configuration.

⊗ Available Intrinsically Safe.

Specifications are subject to change without notice.